

Article number: 203260M841A1X  
 Description: E+G levelling foot  
 GN 32-60-M8-41-A1-X  
 Note: X With female thread, External hexagon

## Measures

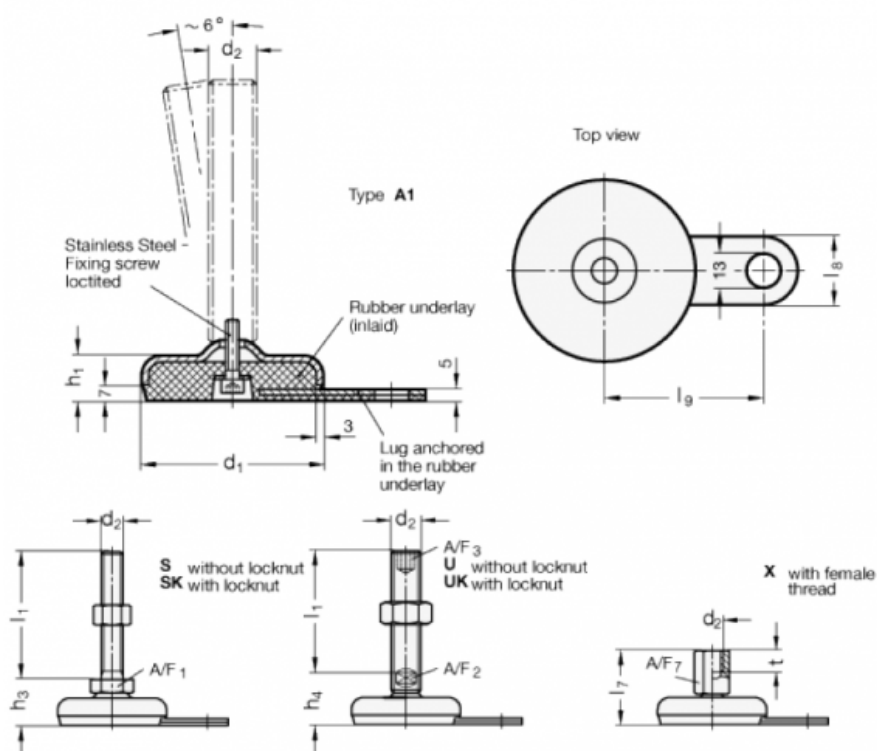

A/F7	= 14
d1	= 60
d2	= M8
h1	= 19
l7	= 41
l8	= 25
l9	= 50
t	= 8